

HANDBOOK (V 7.0)
DOME
ELECTRODES



Caution: Federal law restricts this device to sale by or on the order of a physician.

CONTENTS

CONTENTS	1
USER ASSISTANCE & SAFETY	2
USER ASSISTANCE	2
GENERAL WARNINGS AND PRECAUTIONS.....	2
ADVERSE REACTIONS.....	3
LABEL SYMBOL DESCRIPTIONS.....	4
OVERVIEW	5
PURPOSE OF THE DEVICE.....	5
INDICATIONS FOR USE.....	5
CONTRAINDICATIONS	5
LIMITATIONS.....	5
DESCRIPTION OF THE DEVICE.....	5
COMPATIBLE DEVICES.....	6
Complete Control System.....	6
CONDITIONS FOR USE	6
INSTRUCTIONS FOR USE	7
ELECTRODE PLACEMENT	7
ELECTRODE CONNECTION.....	7
Assembly Instructions for Placing Dome Electrodes into a Prosthetic Socket Interface.....	8
Assembly Problems.....	9
GENERAL INSTALLATION PRECAUTIONS	9
ELECTRODE CLEANING & MAINTENANCE.....	10
Duration of Use.....	10
Sterilization and Cleaning	10
Maintenance.....	10
COMPONENT SPECIFICATIONS	11
COMPONENTS IN PACKAGE	11
ADDITIONAL INFORMATION	14
LIMITED US WARRANTY	14
EXTENDED WARRANTY.....	15
RETURNS.....	15
REGULATORY INFORMATION	15

USER ASSISTANCE & SAFETY

USER ASSISTANCE

If you are experiencing trouble, contact Coapt for support (toll free) at 844-262-7800.

Additional information, including technical specifications, and instructions for connecting and using the Dome Electrodes can be found online at www.coaptengineering.com

GENERAL WARNINGS AND PRECAUTIONS

For your safety and to prevent damage to the Dome Electrode and connected compatible device, please read and adhere to all safety precautions found in this handbook. In addition, please follow the safety guidelines found in the user manual(s) for any connected compatible device(s). Failure to heed all warnings and precautions could cause injury to the user or damage to the Dome Electrodes. The following symbol definitions pertain to warnings in this handbook and on all product labels.

SYMBOL DEFINITIONS



Warning regarding possible risk of severe accidents or injury.



Warning regarding possible risks of accident or injury.

NOTICE

Warning regarding possible damage to product or equipment.



Read and follow safety instructions. Read this entire manual before setting up and operating the Dome Electrodes. Failure to do so could result in suboptimal system performance or injury to you, the electrodes, or the connected device.



Consult trained specialist. Before using the Dome Electrodes consult a trained specialist. Failure to do so could result in suboptimal system performance or injury to you, the electrodes, or the connected device.



Only Use With Approved Devices. Only use the Dome Electrodes with equipment that has been approved as being compatible. A list of compatible devices that have passed all testing for safety and effectiveness can be requested via email and found at www.coaptengineering.com. Use of the Dome Electrodes with unapproved devices may lead to serious injury to you, the electrodes, or the connected device.



CHOKING HAZARD. Keep away from Children.



Do Not Ingest. Ingestion of the Dome Electrodes and its components may lead to serious injury.

- ⚠ WARNING** **Do Not Apply to Eyes, in the Mouth, or Internally.** Application of the Dome Electrodes to the eyes, in the mouth or internally may lead to serious injury.
- ⚠ WARNING** **Only the Dome Should Make Contact with User.** Only the Dome side of the Dome Electrode should make physical contact with the user. Contact of the threaded side or other components with the user may cause serious injury.
- ⚠ WARNING** **Do Not Apply to Medically Compromised Skin.** Application of the Dome Electrodes to medically compromised or broken skin may lead to serious injury.
- ⚠ WARNING** **Do Not Modify.** Modification of the Dome Electrode may only occur with express authorization from Coapt. Unauthorized modification of the Dome Electrode may lead to serious injury.
- ⚠ CAUTION** **Do Not Use Near Open Flame.** Use care when operating Dome Electrodes near an open flame, and do not allow device to remain directly over an open flame. Direct exposure to an open flame may cause the device to exceed safe temperature limits.
- ⚠ CAUTION** **Use in a corrosive environment.** Do not expose the device to excessive amounts of corrosive substances such as acetone, benzene or similar solution.
- ⚠ CAUTION** **Not for Resale.** This device is intended only for the purchaser for use with approved compatible devices.

ADVERSE REACTIONS

- ⚠ WARNING** **Not for Stimulation.** Do not use the Dome Electrodes for stimulation. Patients may experience headache and other painful sensations during or following the application of electrical stimulation near the eyes and to the head and face.
- ⚠ CAUTION** Patients should stop using the device and should consult with a physician if they experience adverse reactions from the device.

MedWatch is the Food and Drug Administration's (FDA) program for reporting serious reactions, product quality problems, therapeutic inequivalence/failure, and product use errors with human medical products, including drugs, biologic products, medical devices, dietary supplements, infant formula, and cosmetics.

If you think you or someone in your family has experienced a serious reaction to a medical product, you are encouraged to take the reporting form to your doctor. Your healthcare provider can provide clinical information based on your medical record that can help FDA evaluate your report.

However, we understand that for a variety of reasons, you may not wish to have the form filled out by your health care provider, or your health care provider may choose not to complete the form. Your health care provider is NOT required to report to the FDA. In these situations, you may complete the Online Reporting Form yourself.







You will receive an acknowledgement from FDA when your report is received. Reports are reviewed by FDA staff. You will be personally contacted only if we need additional information.

Submitting Adverse Event Reports to FDA

Use one of the methods below to submit voluntary adverse event reports to the FDA:

- Report Online at www.accessdata.fda.gov/scripts/medwatch/index.cfm?action=reporting.home
- Consumer Reporting Form FDA 3500B. Follow the instructions on the form to either fax or mail it in for submission. For help filling out the form, see MedWatchLearn. The form is available at www.fda.gov/downloads/aboutFDA/reportsmanualsforms/forms/ucm349464.pdf
- Call FDA at 1-800-FDA-1088 to report by telephone
- Reporting Form FDA 3500 commonly used by health professionals. The form is available at www.fda.gov/downloads/aboutFDA/reportmanualsforms/forms/ucm163919.pdf

LABEL SYMBOL DESCRIPTIONS

SYMBOL	INFORMATION	EXPLANATION
	Consult Accompanying Documents Symbol	Please read the entire instruction manual before using the device.
	CE Mark	The device is certified with the European Union under the Medical Device Directives (93/42/EEC).
	Serial Number	Signifies the identification information for the device.
	Date of Manufacture	Date the device was assembled at Coapt.
	European Representative	Signifies the European Representative for Coapt.
	Type BF Applied Part	The device has conductive contact with the patient.

OVERVIEW

PURPOSE OF THE DEVICE

The Dome Electrode is an accessory designed for passive sensing of biopotential signals. Muscle contractions produce small electrical biopotentials (voltages). These electrical signals are dispersed to the surface of the skin where the Dome Electrode provides a conduction pathway to an electrical conductor of compatible devices.

The Dome Electrode is designed to work seamlessly with biopotential recording devices as an accessory. It has a standard mating thread that enables connection to electrical conductors of compatible devices.

INDICATIONS FOR USE

The Dome Electrodes are intended for non-invasive use with recording and monitoring equipment of Electromyography (EMG).

CONTRAINDICATIONS

None known.

LIMITATIONS

Consult a trained specialist before use of the Dome Electrodes.

DESCRIPTION OF THE DEVICE

The Dome Electrode is an accessory designed for enhanced detection of biopotential signals. It is a non-invasive electrode that conducts biopotential signals from the surface of the skin. The shape of the electrode simplifies placement and allows users to receive more accurate recording of biopotential signals. The material used allows for an electrode with safety and longevity. The Dome Electrode is designed to work seamlessly with biopotential recording devices as an accessory. It has a standard mating thread that enables connection to electrical conductors of compatible devices.

The Dome Electrodes function in the same method as other traditionally used electrode contacts. Muscle contractions produce small electrical potentials (voltages). These electrical signals are dispersed to the surface of the skin where they can be detected. Electrodes can detect this electrical signal on the surface of the skin because the electrodes create an equipotential area since they are more conductive than skin. The Dome Electrode provides a conduction pathway because the electrical potentials at the surface of the skin following a muscle contraction are attracted to the equipotential surface of the electrode. From there the signal can be sent to electrical conductors of compatible devices.

The Dome Electrode contains the following components:

- 316L Stainless Steel Dome Electrode
- Stainless Steel Size 4-40 Nut
- Stainless Steel Flat Washer
- Stainless Steel Split Lock Washer

COMPATIBLE DEVICES

The Dome Electrode is designed to work seamlessly with biopotential recording devices as an accessory. It has a standard mating thread that enables connection to electrical conductors of compatible devices. It can be used for devices that require the detection or recording of biopotential signals. As more uses of the Dome Electrode become apparent new devices will undergo the same performance testing as the Dome Electrodes with the Coapt **Complete Control** System. Coapt will maintain a list of approved compatible devices that have passed all testing for safety and effectiveness. This list can be requested via contacting Coapt.

Complete Control System

A specific example of an approved compatible device is the Coapt **Complete Control** System. The Dome Electrodes can be used as an accessory to this device and facilitate the recording of EMG signals that will be analyzed by the **Complete Control** System to output as control signals to a prosthesis.

COMPATIBLE DEVICE	MANUFACTURER INFORMATION	USE	TESTING PERFORMED
Complete Control System	Coapt, LLC 222 W Ontario St., Suite 300 Chicago, IL 60654	Dome Electrodes provide input of EMG signals from surface of the skin to the Complete Control System	Compatible Device Connection – Pass Signal Detection – Pass

CONDITIONS FOR USE

The Dome Electrodes are suitable for use in clinical activities, educational/research purposes, prosthetic applications, and for use in most activities of daily living, including home, social, and occupational use. The Dome Electrodes are not to be used for purposes other than those stated in the labeling.

See General Warnings and Precautions section for more information regarding acceptable conditions for using your device.

INSTRUCTIONS FOR USE

ELECTRODE PLACEMENT

The Dome Electrodes should be placed to contact the skin surface of a user per the suggested placement guidelines of the compatible recording device being connected. For example, if the compatible device is a control system for prosthetic arms, follow the locating/placement guideless provided for optimal skin-site placement.

Typical application of the Dome Electrodes will have more than one being placed in relative proximity. For typical bi-polar EMG recordings, the Dome Electrode contacts should be placed in pairs about 30-60mm apart from each other. For the best EMG detection, it is recommended to avoid placing electrode contacts on areas that will lose electrode-to-skin contact during use.

No conductive gel is required for Dome Electrode use. However, for significantly dry skin areas, addition of moisture can ensure good signal detection.

It is recommended that Dome Electrodes are placed in a prosthetic housing material (socket), a cuff enclosure, or similar, to limit movement of the Dome Electrode away from the intended skin placement site.

ELECTRODE CONNECTION

The Dome Electrodes have been designed to be compatible with industry standard biopotential processing devices. The Dome Electrodes are placed so that the dome side will contact the skin surface and the threaded stud on the other side will be placed through a small hole in prosthetic socket wall, or similar enclosure. The biopotential detection devices' conductor cable is connected to the stud on the outside of the prosthetic socket wall and the whole assembly is secured in place using the flat washer, split lock washer, and tightening nut.

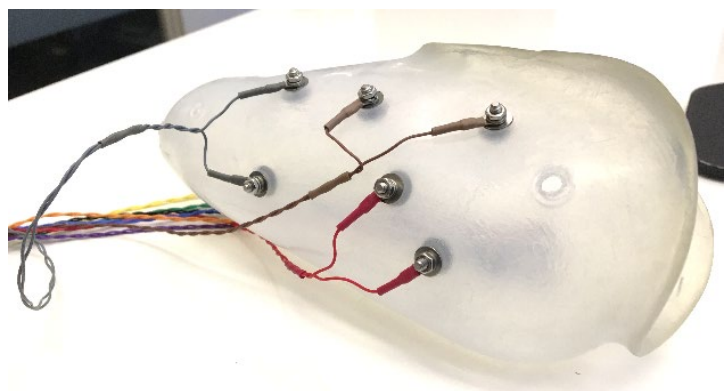
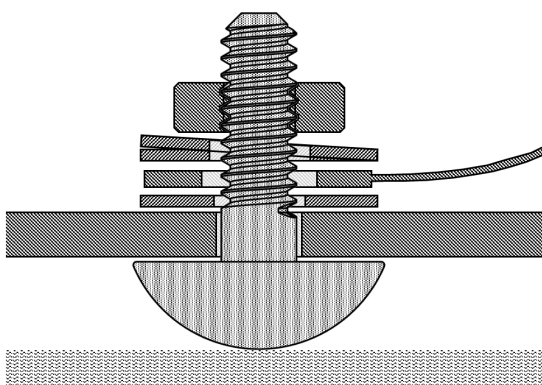

Assembly Instructions for Placing Dome Electrodes into a Prosthetic Socket Interface

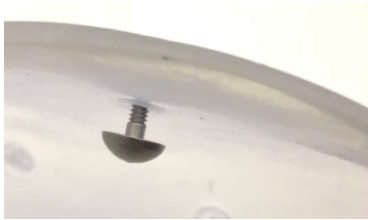

INSERT DOME ELECTRODE

Push a Dome Electrode through a #4 mounting hole made in the prosthesis' inner socket/liner interface. Place it from the inside of the socket interface so the dome side will contact the skin of the user, and the thread is on the outer side of the socket wall. Ensure the Dome Electrode stud is pushed all the way in the so the flat base of the dome is flush with the inside socket wall.



PLACE THE FLAT WASHER

Place a provided Flat Washer on the threaded side of the Dome Electrode, on the exterior of the socket interface.

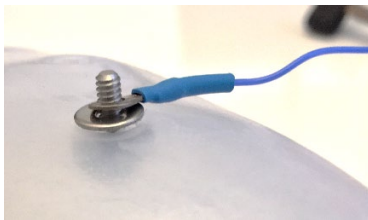

PLACE ONE OR MORE CONDUCTOR CABLE(S)

Place the ring terminal of a conductor cable on top of the Flat Washer. The Dome Electrode is not supplied with the conductor cable. When conductor "sharing" a Dome Electrode, place the other conductor cable(s) ring terminal(s) on this threaded stud.



PLACE THE SPLIT LOCK WASHER

Place a provided Split Lock Washer on top of the ring terminal(s) of the conductor cable(s).



SECURE WITH THE 4-40 THREADED NUT

Place and tighten a provided 4-40 Threaded Nut to secure the assembly. Make sure it is tight enough that the conductor cable wire cannot be moved side-to-side with finger force. Make sure the dome side of the Dome Electrode is flush with the interior surface of the socket interface. Do **NOT** use thread locker.



TRIM AND SMOOTH EXCESS THREADED STUD

Where applicable, trim the excess threaded stud of each Dome Electrode once installed and tightened. Make sure to smooth, remove, or cover any sharp edges.



REPEAT FOR EACH DOME ELECTRODE

Repeat these steps for each Dome Electrode that needs to be connected to a conductor.

Assembly Problems

Please contact Coapt if you are having problems assembling the Dome Electrodes.

GENERAL INSTALLATION PRECAUTIONS

The following safety precautions should be read and followed by the qualified specialist responsible for assembling the Dome Electrode and configuring the compatible device prior to use.

- ⚠ CAUTION**
Trimmed electrode studs. Ensure any excess length of electrode dome threaded studs are sufficiently trimmed and smoothed. Sharp edges and protrusions can cause damage to other prosthesis wiring, socket materials, and installed components.
- ⚠ CAUTION**
Configuration by a qualified professional. The Dome Electrode must be assembled by a qualified specialist.
- ⚠ CAUTION**
Do not cross-thread. Do not try to force 4-40 nut to tighten on thread. Cross threading can cause permanent damage to electrode. Tighten with fingers first, if it is not easy to tighten, remove and adjust orientation of nut.
- ⚠ CAUTION**
Use of excessive force. Do not try to force components/product into socket or cutout holes. Use of excessive force or impact force tools (e.g., hammer) could permanently damage the Dome Electrodes and result in malfunction and minor injury to the user.
- ⚠ CAUTION**
Use with unapproved device. Make sure that the Dome Electrodes are only connected to approved compatible devices. Use with an unapproved device that is incompatible with the system, or was not indicated during product order, may cause damage to and/or malfunction of the Dome Electrodes and device and could result in minor injury to the user.
- ⚠ CAUTION**
Contact with threaded side and components. Ensure that only the dome side of the Dome Electrode makes contact with the user. The threaded side and other components should be secured behind a mounting wall or enclosure. Contact with the threaded side and other components could cause minor injury to the user.
- ⚠ CAUTION**
Compression of compatible conductor cables. Ensure that conductor cables of the compatible device are not compressed between the components of the Dome Electrode. Compression of the conductor cables could cause the cables to fail resulting in device damage, device malfunction, and minor injury to the user.
- ⚠ CAUTION**
Installation in material prone to static buildup. Do not install Dome Electrode in material that is prone to experiencing a buildup of static electricity (e.g., leather, wool, nylon, and lead). Increased amounts of electrostatic discharge events could cause damage to the compatible device, resulting in device malfunction and minor injury to the user.
- NOTICE**
Conductive socket material. It is important to consider electrode interference when using of electrically conductive socket materials, such as carbon fiber laminate. Conductive socket material that comes in contact with electrode dome threaded studs can negatively affect prosthesis performance by reducing the detected EMG signal quality. Take care to electrically isolate the electrode dome threaded stud and/or EMG Interface Cable ring-terminals from contact with any conductive socket materials.

ELECTRODE CLEANING & MAINTENANCE

Duration of Use

The Dome Electrodes can safely be used for up to 24 hours a day. The Dome Electrodes underwent and received passing results for biocompatibility testing under ISO 10993 as a prolonged skin contact surface device for cytotoxicity, skin sensitization, and irritation.

Sterilization and Cleaning

The Dome Electrodes are provided non-sterile. The user can sterilize and clean them according to the procedure below before use and at any time. The Dome Electrodes are reusable and should also be sterilized and cleaned before re-using on another user. Follow this procedure to properly clean and sterilize the Dome Electrodes:

1. Prepare by soaking a clean cloth or paper towel with at least 97% isopropyl alcohol. Avoid using anything abrasive like sandpaper or steel wool.
2. Use this prepared cloth to wipe the dome surface that will make cutaneous contact with the user.
3. Allow the Dome Electrodes to air dry before making cutaneous contact.

Maintenance

The Dome Electrodes should be cleaned and installed properly.

The Dome Electrodes should be inspected regularly for appearance of any corrosion and/or oxidization on the dome surface. While this is not expected, it could result in minor degradation of Dome Electrode conductivity and performance. Proper cleaning and installation will prevent surface corrosion and/or oxidization.

If the Dome Electrodes appear to be rusted they should no longer be used. Exposure to rust can increase the risk of tetanus if the Dome Electrodes are in close proximity to broken skin.

COMPONENT SPECIFICATIONS

COMPONENTS IN PACKAGE

The Dome Electrode kit comes packaged with the following components. Contact Coapt for more information.

316L STAINLESS STEEL DOME ELECTRODES

DOME ELECTRODE



QUANTITY IN PACKAGE

18

Diameter: 0.375 in (9.525 mm)
Height: 0.130 in (3.302 mm)

DIMENSIONS OF DOME

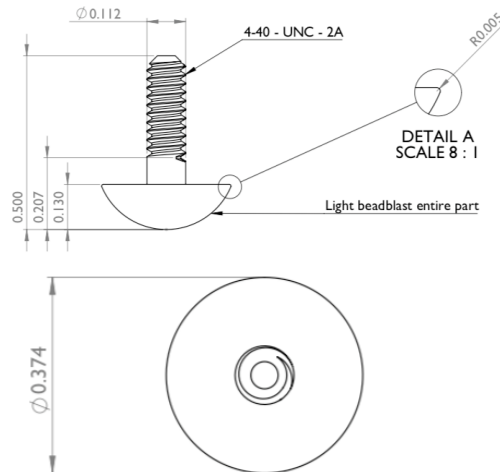

DIMENSION OF THREAD

Diameter: 0.112 in (2.845 mm)
Height: 0.37 in (9.398 mm)

TOTAL DOME SURFACE AREA

0.43 in² (2.80 cm²)

CONNECTION

4-40 thread

MATERIAL

316L Stainless Steel

RECORDING FREQUENCY BAND

0-1000Hz

STAINLESS STEEL THREADED NUTS

4-40 THREADED NUT



QUANTITY IN PACKAGE

18

Width: 0.1875 in (4.7526 mm)
Height: 0.0625 in (1.5875 mm)

DIMENSIONS

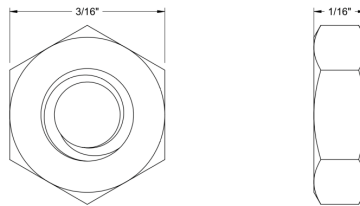

CONNECTION

4-40 thread

MATERIAL

18-8 Stainless Steel

STAINLESS STEEL FLAT WASHERS

FLAT WASHER



QUANTITY IN PACKAGE

18

Internal Diameter: 0.125 in (3.175 mm)
External Diameter: 0.312 in (7.925 mm)
Thickness: 0.025-0.040 in (0.635-1.016 mm)

DIMENSIONS

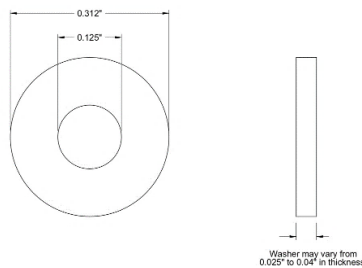

CONNECTION

No. 4 screw size

MATERIAL

18-8 Stainless Steel

STAINLESS STEEL SPLIT LOCK WASHERS

SPLIT LOCK WASHER



QUANTITY IN PACKAGE

18

Internal Diameter: 0.120 in (3.048 mm)
External Diameter: 0.209 in (5.3086 mm)
Thickness: 0.025 in (0.635 mm)

DIMENSIONS

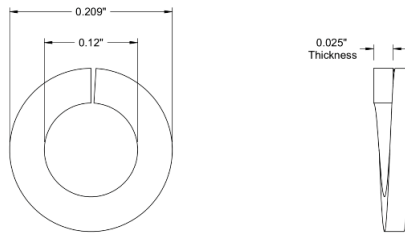

CONNECTION

No. 4 screw size

MATERIAL

18-8 Stainless Steel

ADDITIONAL INFORMATION

LIMITED US WARRANTY

For purposes of warranty, the “Customer” is defined as the entity that Coapt, LLC (“Coapt”) has invoiced for the Coapt component(s) (“Items”). The 2 Year Limited Warranty only applies to Items sold to the Customer by Coapt or an authorized distributor. For an integrated prosthetic system consisting of products or components purchased from both Coapt and other suppliers/manufacturers, in the event that such a system is sent into Coapt for warranty review, if it is found during evaluation the reported problem(s) is associated with a product or component not supplied by Coapt, a “Non-Warranty Evaluation Charge” may be invoiced to the Customer.

Coapt warrants its Items will be free from defects in material and/or workmanship for a period up to two (2) years. In the absence of a prompt notice from the clinician regarding a delay in fitting the patient, Coapt will set the Limited Warranty start date at 30 days after the shipping date. The Limited Warranty becomes null and void if complete payment is not made within the terms specified under Items’ Payment Terms.

This Limited Warranty covers all defects incurred in the clinically-prescribed use of the Items and does not cover: a) loss or damage due to theft, fire, flood, acts of nature or damage otherwise deemed intentional or abusive; b) damage due to failure to follow operating and installation instructions; c) damage incurred by malfunction or improper use of 3rd party components including leaking, damaged or malfunctioning batteries and cabling; d) use in a way not recommended by the manufacturer/distributor; e) Items serviced or modified by an entity other than Coapt (if the service or modifications are in any way related to the problem or defect); f) substitution of parts not approved by Coapt; g) any alteration or repair that, in Coapt's judgment, materially or adversely affects the Items. Damage as the result of normal wear and tear which does not materially affect the function of the system is not covered.

Any warranty claim shall be reported to Coapt immediately upon discovering the defect. The defective Items must be returned to Coapt or any other Coapt authorized representative. In returning the Items for repair, the Items must be delivered in packaging offering a sufficient degree of protection. The Items must be accompanied by written evidence of the date of purchase, such as invoice. Coapt will not be responsible for any loss or damage in connection with the return of the Items.

The warranty on repaired or replaced Items will be ninety (90) days or until the end of the original warranty, whichever is longer. Coapt will, at its option, repair, replace, or upgrade defective Items returned within this Limited Warranty Period. It is the Customer’s responsibility to adhere to all Federal and State mandated shipping policies, especially regarding shipments including Lithium-Ion Batteries. Items covered by this Limited Warranty will be repaired, replaced, or upgraded in the United States by Coapt representatives, without charge. Coapt will return the Items to the Customer via UPS ground service or using any comparable carrier. Requests for expedited returns of warranty repairs will be at the expense of the customer or covered by Coapt.

THE FOREGOING LIMITED WARRANTY IS COAPT'S ONLY WARRANTY WITH RESPECT TO THE ITEMS AND COAPT MAKES NO OTHER WARRANTY WHATSOEVER, WRITTEN OR ORAL, EXPRESS OR IMPLIED, REGARDING THE ITEMS, INCLUDING WITHOUT LIMITATION ANY WARRANTY OF MERCHANTABILITY, FITNESS FOR A PARTICULAR PURPOSE OR NON- INFRINGEMENT.

This Limited Warranty gives the consumer specific legal rights. The consumer may also have other legal rights which vary from state to state in the U.S., if so some of the above limitations may not apply. If it is determined by a court of competent jurisdiction that a certain provision of this Limited Warranty does not apply, such determination shall not affect any other provision of this Limited Warranty and all other provisions shall remain in effect. This Limited Warranty is given by Coapt, with respect to Items purchased from Coapt in the United States.

EXTENDED WARRANTY

Additional year(s) warranty extensions are available for purchase at the time of original system purchase. Please contact a Coapt representative for pricing and terms.

RETURNS

Users should return all malfunctioning, damaged, or undesired Dome Electrodes and components directly to Coapt, LLC at:

Coapt, LLC
ATTN: Returns
222 W Ontario St., Suite 300
Chicago, IL 60654

REGULATORY INFORMATION



Coapt, LLC is registered with the Food and Drug Administration of the United States Government (Registration Number: 3010605876; Owner Operator Number: 10045459) for the manufacture and supply of prosthetics and orthotics products.

The Dome Electrodes have been cleared as substantially equivalent to a legally marketed predicate device as a Class II device via Section 510(k) premarket notification; K190416.



The Dome Electrodes were designed in conformance with the FDA recognized consensus standard IEEE 2010-2012: Recommended Practice for Neurofeedback Systems (FDA Recognition #17-13).



The biological safety of the Dome Electrode was evaluated in accordance with ISO 10993-1:2009 Biological evaluation of medical devices- Part 1: Evaluation and testing within a risk management process. The Dome Electrodes passed biocompatibility testing for ISO 10993-5: Tests for In Vitro Cytotoxicity, and ISO 10993-10: Tests for Irritation and Skin Sensitivity.



This device is fully compliant with the CE Marking Requirements under the European Medical Device Directive (MDD). Coapt, LLC's European Union Authorized Representative (EC REP) is Fillauer Europe AB.



222 W Ontario St., Suite 300 | Chicago, IL 60654 | 844.262.7800
www.coaptengineering.com | © 2020